

Generation of Adaptive Finite Element Meshes Based on Approximation Surfaces

Volker Berkhahn¹, Matthias Göbel², Oliver Stoschek³, Andreas Matheja⁴

In order to overcome shortcomings of triangulation based meshing tools a new type of mesh generation tool has been developed. At first, the significant geometric shape of the bathymetry is approximated by free form surfaces using the input information from measurements, digital surface models and maps. Different editor tools take advantage of the specific structure of sounding data, such as cross sections, longitudinal profiles or scattered data. Based on these approximating surfaces, which are connected C1 continuously, any mesh with user specified criteria can easily be generated. These quadrilateral or triangle meshes may be equidistant, regular or unstructured due to different refinement criteria.

The advantage of this new mesh generation tool is demonstrated within a project to simulate and to predict the amount of cohesive sediment movement in the estuary of the tidal Weser River. In this realistic example two different criteria for mesh refinement are applied: At first, all elements are refined due to the depth of the element nodes. In addition, the user specifies refinement areas with special importance of the numerical results. The effort to generate the mesh, the quality of the mesh and the results of the numerical simulation are evaluated.

Introduction

Numerical simulations of hydrodynamic problems require a discrete element mesh of the area to be investigated. These meshes and the geometric description of bathymetries are based on various measurements, digital surface models and additional information gained by maps. Many of the commonly used mesh generators use the depth measurement points directly as element nodes. This leads to an uneven and from the physical point of view to an undesirable distribution of element nodes. Using data from different field campaigns or gaps and overlaps between different measurement regions may cause additional problems. In order to overcome these shortcomings a new type of mesh generation tool has been developed, which is based on the methods of geometric modelling.

These methods of geometric modelling are used with success in computer sciences and engineering in order to generate and visualize geometry. In this paper the adaptation of these well-proved methods to problems dealing with natural systems is presented. For numerical simulations of the hydrodynamic behaviour of rivers, waterways, harbours and coastal lines the corresponding bathymetries have to be described with element meshes in a discrete form. In order to generate these finite element meshes or finite difference meshes as presented in this paper the bathymetries are approximated with spline surfaces. Based on these approximating surfaces structured and adaptive element meshes could easily be generated (Berkhahn, Göbel, Piasecki 2001). Due to the large number of measurement points describing originally the bathymetry, very effective methods to calculate the coordinates of the surface control points have been developed.

¹ Institute of Computer Science in Civil Engineering; University of Hannover, Germany;
berkhahn@bauinf.uni-hannover.de

² Projektionisten GmbH; Hannover, Germany; goebel@projektionisten.de

³ Franzius-Institute for Hydraulic, Waterways and Coastal Engineering; University of Hannover, Germany;
oliver.stoschek@fi.uni-hannover.de

⁴ Franzius-Institute for Hydraulic, Waterways and Coastal Engineering; University of Hannover, Germany;
am@fi.uni-hannover.de

Free Form Geometry

Free form geometries are widely used in computer aided geometric design and re-engineering of surfaces in order to describe the geometric shape of technical products (Hoschek, Lasser, 1992) (Farin, 1999). Often Bézier curves and surfaces fulfil the requirement of generating smooth geometry. In the field of bathymetry approximation based on a large number of scattered data Bézier surfaces show the disadvantageous property of global modelling. Therefore the concept of Bézier surfaces is generalized to the concept of segmented surfaces, which leads to the surface representation with b-splines (Farin, 2002). A b-spline surface is defined by

$$\mathbf{b}(u, v) = \sum_{i=0}^N \sum_{j=0}^M \mathbf{b}_{ij} N_i^K(u) N_j^L(v) \quad . \quad 1$$

In equation 1 all expressions in bold face indicate a point in the three dimensional Euclidian space E^3 . On the left hand side of this equation $\mathbf{b}(u, v)$ denotes a point on the b-spline surface in dependence of the two parameters u and v . The first expression in the double sum \mathbf{b}_{ij} describes a regular grid of $N+1$ control points in u parameter direction and $M+1$ control points in v parameter direction. These control points \mathbf{b}_{ij} are called de Boor points.

The shape functions in u and v parameter directions are called b-spline functions $N_i^K(u)$ and $N_j^L(v)$, where the upper indices K and L indicate the degree of the b-spline functions.

In order to ensure the property of local modelling possibility the influence of the de Boor points with respect to the shape of the surface has to be restricted to a specified parameter range. Therefore the b-spline functions of degree 0 are defined as follows

$$N_i^0(u) = \begin{cases} 1 & \text{for } u \in [u_i, u_{i+1}[\\ 0 & \text{else} \end{cases} \quad \text{for } i = 0, \dots, N+K \quad . \quad 2$$

In equation 2 u_i and u_{i+1} denote the lower and upper bounds of the i^{th} parameter interval. All bounds of the parameter intervals are gathered in the knot vector \mathbf{u}

$$\mathbf{u} = [u_0, \dots, u_{N+K+1}]^T \quad . \quad 3$$

In this manner the b-spline functions $N_i^0(v)$ in dependence of the parameter v are defined with the knot vector \mathbf{v} according to equations 2 and 3. The b-spline functions of degree r are given with the recursive formula

$$N_i^r(u) = \frac{u - u_i}{u_{i+r} - u_i} N_i^{r-1}(u) + \frac{u_{i+r+1} - u}{u_{i+r+1} - u_{i+1}} N_{i+1}^{r-1}(u) \quad \text{for } \begin{matrix} r = 1, \dots, N+K \\ i = 0, \dots, N+K-r \end{matrix} \quad . \quad 4$$

It is evident that the b-spline function N_i^r of degree r is based on the b-spline functions N_i^r and N_{i+1}^r of degree $r-1$. This ensures the important property of local modelling possibility

$$N_i^r(u) = 0 \quad \text{for } u \in \mathbb{R} \setminus]u_i, u_{i+r+1}[\quad . \quad 5$$

For the example of an equidistant knot vector the corresponding quadratic b-spline functions $N_i^2(u)$ are shown in figure 1.

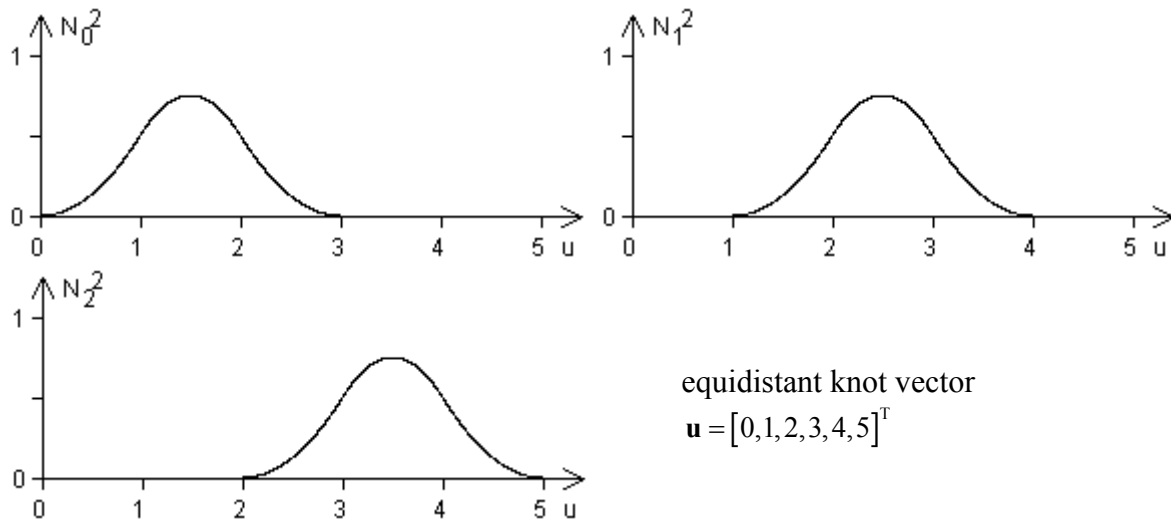

Figure 1 Quadratic b-spline functions

The equation 1 has to be an affine combination which means that the factors of all de Boor points for every parameter combination u and v have to summarize to 1. This requirement is only fulfilled within the intervals

$$\sum_{i=0}^N N_i^K(u) = 1 \text{ for } u \in [u_K, u_{N+1}] \text{ or} \quad 6$$

$$\sum_{j=0}^M N_j^L(v) = 1 \text{ for } v \in [v_L, v_{M+1}],$$

respectively. Therefore the definition 1 is restricted to the parameter intervals $u \in [u_K, u_{N+1}]$ and $v \in [v_L, v_{M+1}]$. An example b-spline surface with $K = L = 3$, $N = 5$, $M = 4$ and equidistant knot vectors \mathbf{u} and \mathbf{v} is shown in figure 2. The grid of de Boor points is shown in dark grey and the corresponding b-spline surface is presented in black.

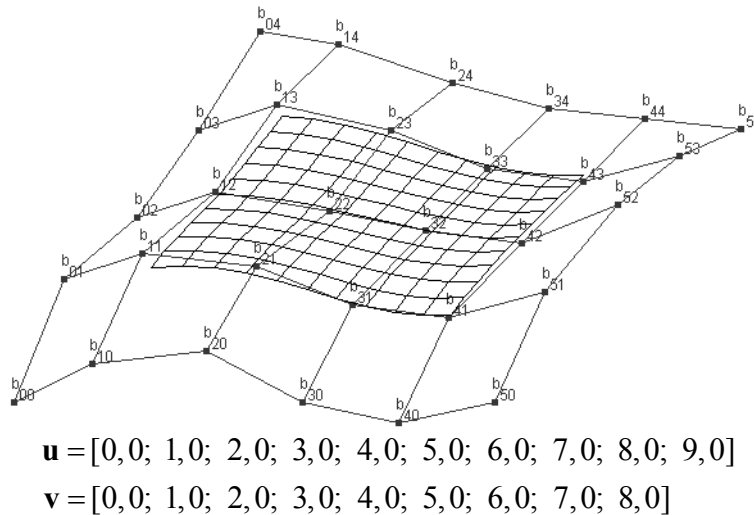

Figure 2 B-spline surface without endpoint interpolation

As shown in figure 2 the b-spline surface with equidistant knot vectors does not interpolate the end control points. End point interpolation is an important property to construct C^0 continuous connections between different b-spline surfaces. Therefore K -multiple knots in the knot vector \mathbf{v} or L -multiple knots in the knot vector \mathbf{u} , respectively, are introduced. For a boundary curve in u -parameter direction these multiple knots lead to

$$\mathbf{b}(u) = \sum_{i=0}^N \mathbf{b}_i N_i^K(u) \text{ with } u \in [u_K, u_{N+1}]$$

$$u_{j+1} = \dots = u_{j+K} =: u^* \text{ for } 0 \leq j \leq N$$

$$\mathbf{b}_j = \mathbf{b}(u^*) \text{ .}$$

7

These K- and L-multiple knots assures a b-spline surface interpolating the end de Boor points. The same b-spline surface as shown in figure 2 with $K = L = 3$, $N = 5$, $M = 4$ but with knot vectors \mathbf{u} and \mathbf{v} containing multiple end knots is presented in figure 3.

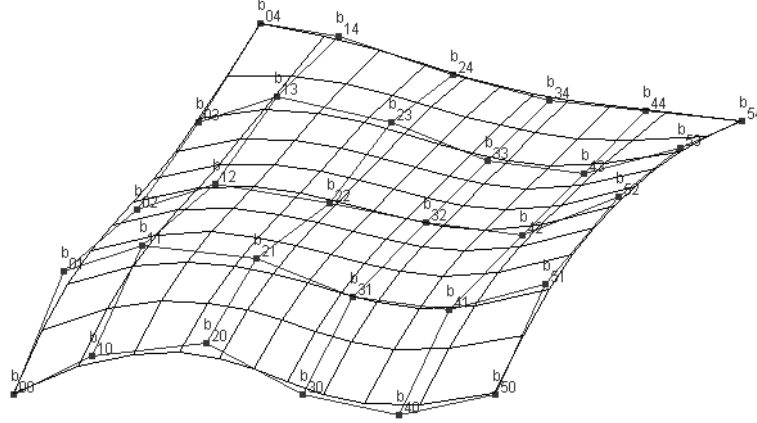

$$\mathbf{u} = [0, 0; 0, 0; 0, 0; 0, 0; 1, 0; 2, 0; 3, 0; 3, 0; 3, 0; 3, 0]$$

$$\mathbf{v} = [0, 0; 0, 0; 0, 0; 0, 0; 1, 0; 2, 0; 2, 0; 2, 0; 2, 0]$$

Figure 3: B-spline surface with endpoint interpolation

Approximation of Scattered Data

At least $(N + 1)(M + 1)$ measurement points \mathbf{p} have to be provided in order to avoid an undetermined system of equations for the coordinates of the de Boor points. Equidistant knot vectors \mathbf{u} and \mathbf{v} with K- and L-multiple end knots are chosen. The unknown de Boor points \mathbf{b}_{ij} are chosen in a regular and equidistant grid related to local x- and y-coordinates. Thus the z-coordinates of the de Boor points are to be calculated. Every measurement point \mathbf{p}_m can be expressed as a point on the approximating b-spline surface $\mathbf{b}(u, v)$

$$\mathbf{p}_m = \mathbf{b}(u_m, v_m) \text{ .} \quad 8$$

Equation 8 represent three independent equations for the x-, y- and z-coordinates. The equations for the x- and y-coordinates can be used for calculating the unknown parameters u_m and v_m for every measurement point \mathbf{p}_m on the b-spline surface

$$p_{xm} = b_x(u, v) = \sum_{i=0}^N \sum_{j=0}^M b_{xij} N_i^K(u_m) N_j^L(v_m) \text{ .} \quad 9$$

$$p_{ym} = b_y(u, v) = \sum_{i=0}^N \sum_{j=0}^M b_{yij} N_i^K(u_m) N_j^L(v_m)$$

As the parameters u_m and v_m for every measurement point \mathbf{p}_m are calculated, the only unknown values in equation 10 are the z-coordinates of all de Boor points

$$p_{zm} = b_z(u, v) = \sum_{i=0}^N \sum_{j=0}^M b_{zij} N_i^K(u_m) N_j^L(v_m) \text{ .} \quad 10$$

This leads to an over-determined system of equations, which can be solved with a decomposition method (Matheja, Stoschek, Berkhahn, 2001). In realistic cases this is a time and memory consuming process.

Therefore a high efficient iteration algorithm is developed: For every de Boor point \mathbf{b}_{ij} the corresponding measurement points \mathbf{p}_m which are in his sphere of influence are selected. Based on these selected measurement points the mean value of their z-coordinates is calculated. This mean value $\bar{p}_{z(ij)}$ has to be the z-coordinate of the b-spline surface at the parameters u_{ij} and v_{ij} of the de Boor point \mathbf{b}_{ij}

$$\bar{p}_{z(ij)} = \mathbf{b}_z(u_{(ij)}, v_{(ij)}) \quad . \quad 11$$

At the first iteration step the z-coordinates of all de Boor point \mathbf{b}_{zij} are set to $\bar{p}_{z(ij)}$ which leads to the deviations Δ_{zij}

$$\tilde{\mathbf{b}}_{zij}^0 = \bar{p}_{z(ij)} \Rightarrow \Delta_{zij}^0 = \mathbf{b}_z(u_{(ij)}, v_{(ij)}, \tilde{\mathbf{b}}_z^0) - \bar{p}_{z(ij)} \quad . \quad 12$$

The z-coordinates of all de Boor point are improved with the corresponding deviations and the iteration process will be continued until the deviations Δ_{zij} are small enough

$$\tilde{\mathbf{b}}_{zij}^n = \tilde{\mathbf{b}}_{zij}^{n-1} + \Delta_{zij}^{n-1} \Rightarrow \Delta_{zij}^n = \mathbf{b}_z(u_{(ij)}, v_{(ij)}, \tilde{\mathbf{b}}_z^n) - \bar{p}_{z(ij)} \quad \text{for } n > 0 \quad . \quad 13$$

This iteration algorithm is proved for the calculation of large-scale b-spline surfaces with several thousands of de Boor points (Berkhahn 2002).

Generation of Finite Element Meshes

Since the approximating b-spline surface is based on a regular de Boor point grid it is very easy to generate a regular element mesh. The element nodes \mathbf{n} are generated on the b-spline surface with equidistant parameter distances Δu and Δv

$$\mathbf{n}_{ij} = \mathbf{b}(u_0 + i\Delta u, v_0 + j\Delta v) \quad . \quad 14$$

Any other criteria based on the geometry of the b-spline surface can be used to generate other element pattern. Using a common refinement method, the new nodes are defined by a linear interpolation between existing element nodes. Instead of this conventional mesh refinement the new nodes are created by a linear interpolation in the uv-parameter space. Thus the refinement nodes are placed on the b-spline surface and describe the bathymetry with increased accuracy.

Example

As a real world example the estuary of the Weser River in Germany is approximated with b-spline surfaces and a triangle element mesh is generated. In figure 4 the initial situation with measurement points of the estuary is shown (data source: Bundesanstalt für Wasserbau, 2001). These measurement points contain gaps and overlaps between the areas of measurement campaigns. The main river will be approximated with b-spline surfaces. This approximation surface is adapted thoroughly to the course of the river. Figure 5 demonstrates the 11*180 de Boor point grid defining the b-spline surfaces shown in figure 6. In these perspective figures the z-coordinate is scaled by the factor of 30.

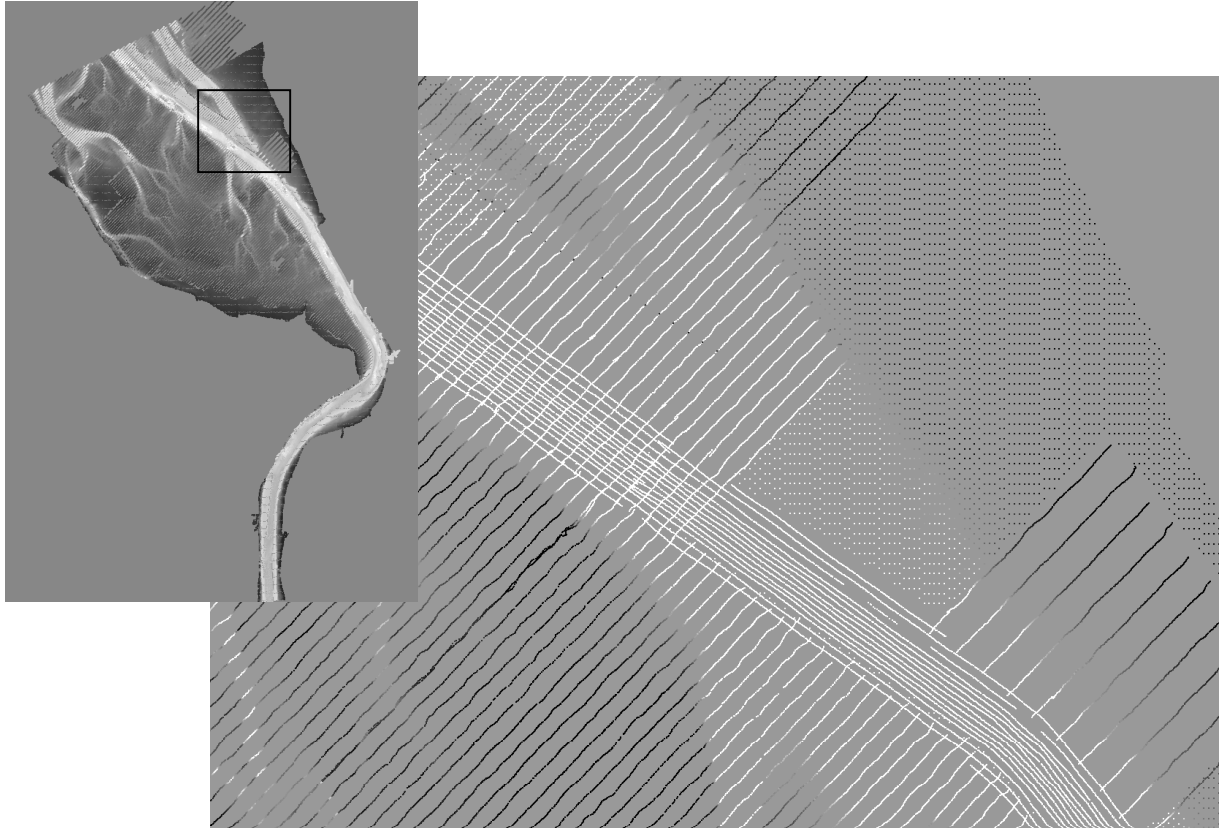

Figure 4 measurement points of the estuary of the Weser River

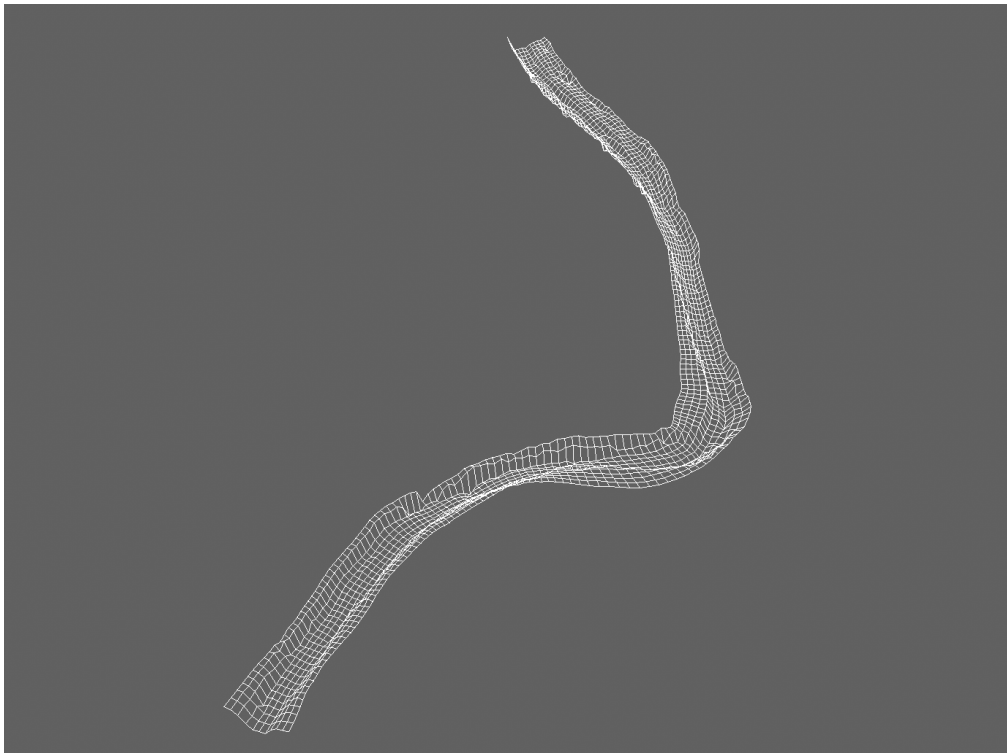

Figure 5 de Boor point grid of the main river

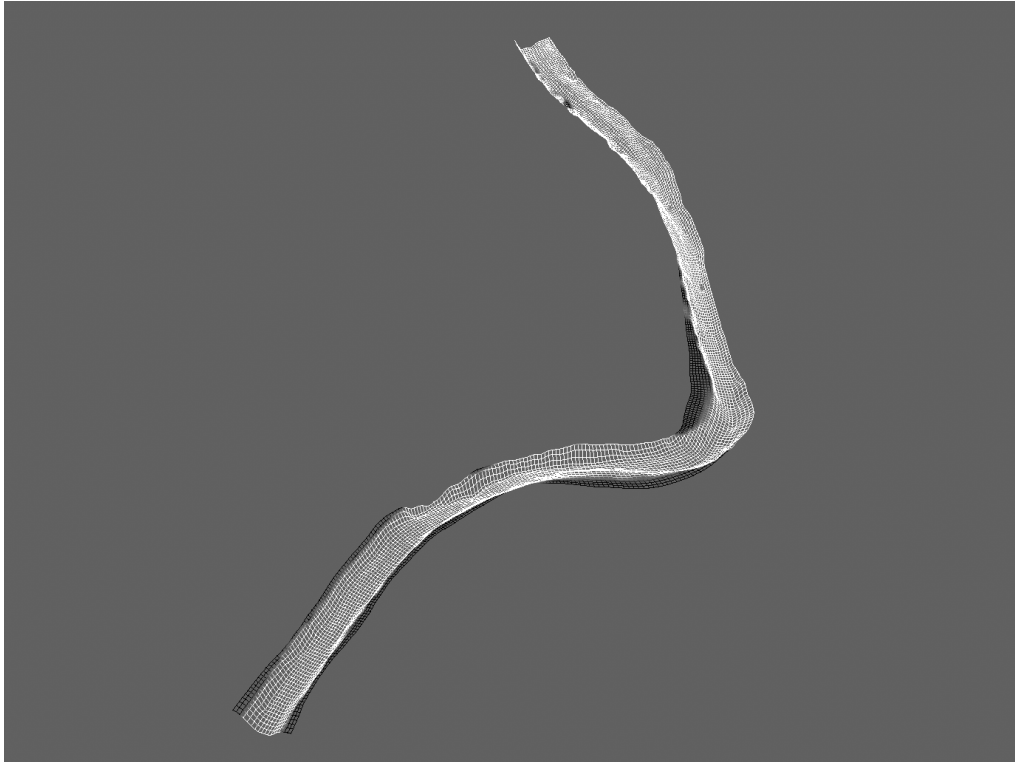

Figure 6 b-spline surface of the main river

Based on these free form surfaces a starting triangle mesh is generated for the main river. The elements in the areas besides the main river are generated as a regular adapted triangle mesh. This starting mesh is shown in figure 7.

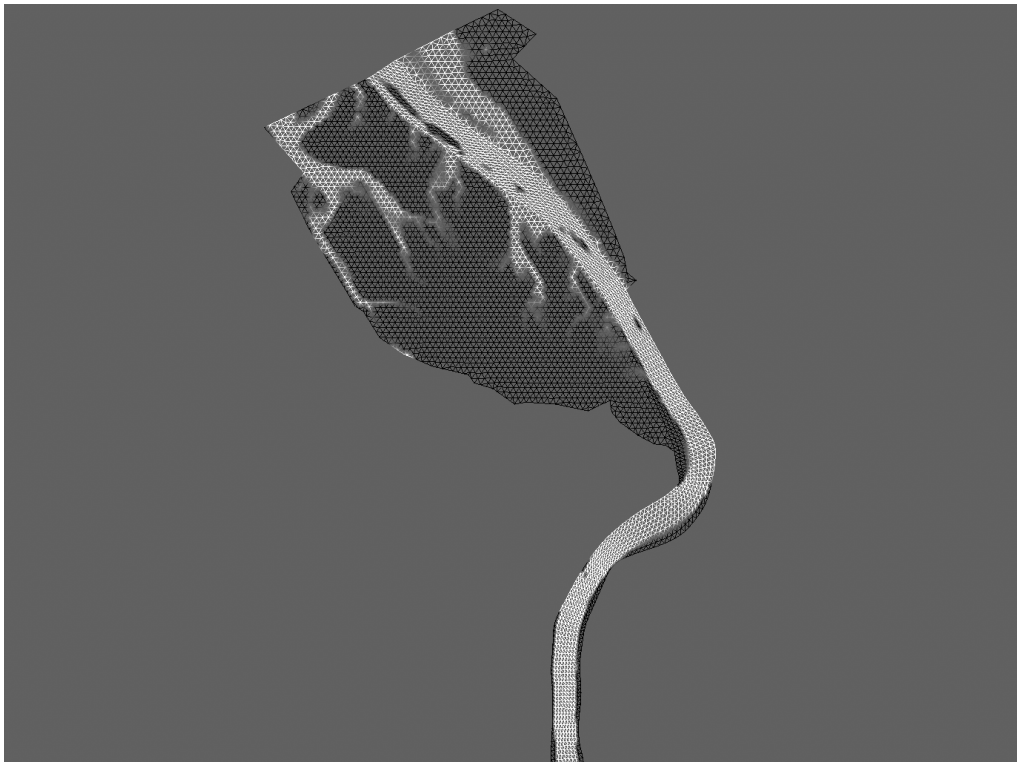

Figure 7 b-spline surface based triangle mesh of the main river and regular adapted mesh of the tidal areas

In a second step this starting mesh is refined in areas where the z -coordinates of the element nodes are greater $-2,0$ m . This refined mesh is shown in figure 8 and 9.

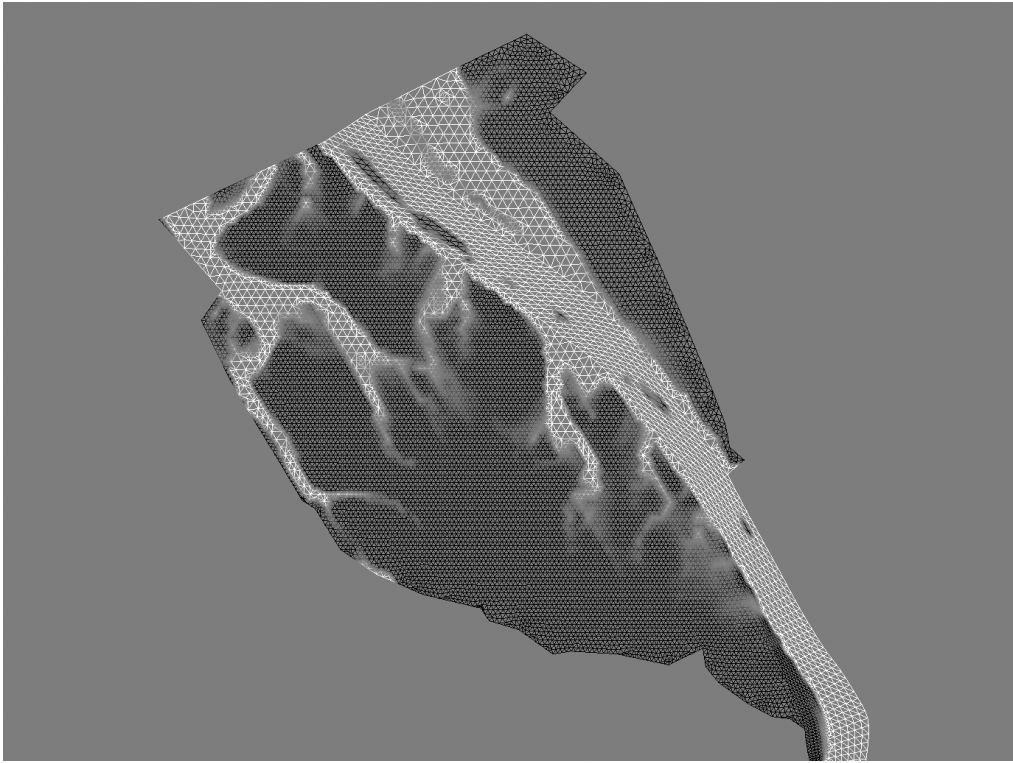

Figure 8 final triangle element mesh (refinement level $z = -2,0$ m)

The boundary conditions of this final triangle mesh is post processed within the SMS Surface-Water Modelling System from Boss International¹.

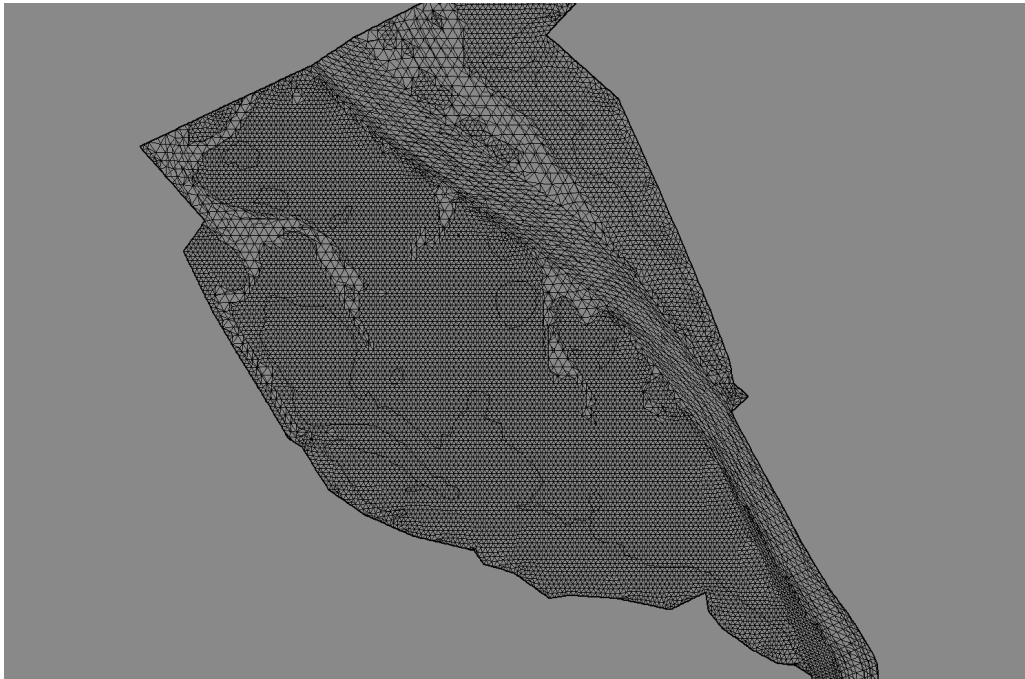

Figure 9 final triangle element mesh within the SMS Surface-Water Modelling System

¹ www.bossintl.com

Results of Numerical Simulations

The 2D-numerical simulations were carried out with the RMA2 model from the Waterway Experiment Station (WES). The northern boundary is defined by a tidal water level boundary. The southern boundary is defined by a tidal discharge. Tidal boundary conditions need an advanced mesh for stable computations of flow velocities. Even the large wet/dry area needs special attention. No wet ponds should be left when reaching ebb. It is difficult for a model to integrate ponds back into the calculation after rewetting the area. Figure 10 shows a results of the calculation during an ebb period. The velocity vector show the direction, the magnitude is given by the shading. Parts of the mesh are already dry (white area).

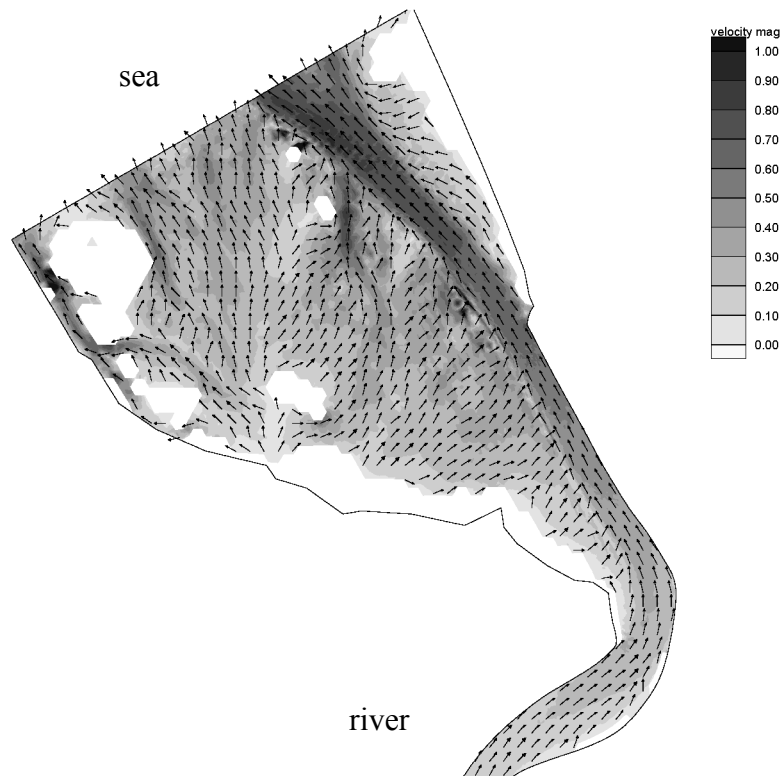

Figure 10 results of a tidal simulation

Conclusion

The authors succeed in adapting established methods of computer aided geometric design to mesh generation problems. The presented tool is designed for the pre-processing of numerical simulations in hydrodynamics. This mesh generation tool is specified for user defined mesh requirements and in realistic cases it is proved to be high efficient and accurate. The process of adapting the meshing tool to user specified requirements will be continued within new cooperations with hydrodynamic research groups.

References

- Berkhahn V., Göbel M., Piasecki M. 2001. Numerical Simulation of Hydrodynamics Based on B-Spline Surfaces; 4th International Symposium on Environmental Software Systems, ISESS 2001. Banff, Canada.
- Berkhahn, V. 2002. Mesh Generation for Hydrodynamic Simulations. Conference on Information Technology and its Applications in Civil Engineering. Teheran, Iran.
- Farin G. E. 1999. Non Uniform Rational B-Splines, From Projective Geometry to Practical Use. Natick Peters.
- Farin, G. E. 2002. Curves and Surfaces for Computer Aided Geometric Design. Morgan Kaufmann.
- Hoschek J., Lasser D. 1992. Grundlagen der geometrischen Datenverarbeitung. B.G. Teubner, Stuttgart.
- Matheja A., Stoschek O., Berkhahn V. 2001. Mesh Generation for RMA2/FESWMS Based on B-Spline Surfaces. 3th International Symposium on Environmental Hydraulics, ISEH 2001. Tempe, Arizona, USA.